

400 HC3 SERIES

TELESCOPIC HI-CAPACITY BOOM LIFTS



Performance

Platform Height		
400S HC3	40 ft	12.19 m
460SJ HC3	46 ft	14.05 m
Horizontal Outreach		
400S HC3	33 ft 6.9 in.	10.23 m
460SJ HC3	39 ft 11.4 in.	12.23 m
Swing	360 Degrees Continuous	
Platform Capacity		
400S HC3 - Restricted	750/1000 lb	340/454 kg
400S HC3 - Unrestricted	660 lb	300 kg
460SJ HC3 - Restricted	750/1000 lb	340/454 kg
460SJ HC3 - Unrestricted	660 lb	300 kg
Platform Rotator	180 Degrees Hydraulic	
Jib (460SJ HC3 only)		
Range of Articulation	6 ft	1.83 m
	130 Degrees (+70, -60)	
Weight*		
400S HC3	15,040 lb	6,822 kg
460SJ HC3	19,260 lb	8,736 kg
Max. Ground Bearing Pressure		
400S HC3	65 psi	4.57 kg/cm ²
460SJ HC3	99 psi	6.96 kg/cm ²
Drive Speed	4.25 mph	6.8 km/h
Gradeability	45%	
Tilt Cut Out	5 Degrees	
Turning Radius		
400S HC3 - Outside	15 ft 8.6 in.	4.8 m
400S HC3 - Inside	6 ft 9.4 in.	2.07 m
460SJ HC3 - Outside	15 ft 8.6 in.	4.8 m
460SJ HC3 - Inside	6 ft 9.4 in.	2.07 m

Standard Specifications

Power Source

Dual Fuel Engine		
Kubota WG2503 DF	61 hp	45.5 kW
Diesel Engine		
Deutz D2.9L4 Tier 4 Final	49 hp	36.4 kW
Fuel Tank Capacity	22 gal.	83.3 L

Hydraulic Reservoir

Hydraulic Reservoir	36 gal	136.27 L
Auxiliary Power	12V-DC	

Tires

Standard	33x12 Foam Filled Tires	
----------	-------------------------	--



3 Capacity Zones - Each rated for 3 occupants + tools/materials

Standard Features

- 180 Degree Hydraulic Platform Rotator
- Platform Console Machine Status Light Panel; Interactive Display at Ground Controls
- 110V-AC Receptacle in the Platform
- 5 Degree Tilt Alarm/Indicator Light
- Swing Out Engine Tray
- 12V-DC Auxiliary Power
- Hourmeter
- Improved Multi-Function Controls
- Proportional Controls
- Platform Console Machine Status Light Panel; Interactive Display at Ground Controls
- Control ADE® System
- Lifting/Tie Down Lugs
- Horn
- Four-Wheel Hydrostatic Drive
- Oscillating Axle
- Motion Alarm
- Glow Plugs (Diesel Engines)
- Load Sensing System
- SkyGuard SkyLine™

*Provides indicator lights at platform and ground control consoles for envelope zone base on platform load, system distress, low fuel, 5 degree tilt light, and foot switch status.

Accessories & Options

- Inward Self-Closing Swing Gate
- 36 x 72 in. (0.91 x 1.83 m) Platform
- Fall Arrest Platform 36 x 72 in. (0.91 x 1.83 m)
- 1/2 in. Air Line to Platform
- Soft Touch System
- AC Generator
- Bolt On External Fall Arrest
- SS Mesh to Top Rail
- White Noise Alarm
- Pipe Racks
- Battery Disconnect
- Top Rail Extension
- SkySense™
- Flashing Amber Beacon
- 43.5 lb (19.73 kg) Propane Tank
- Cold Weather Package¹
- Arctic Package²
- Hostile Environment Kit³
- Light Package⁴
- Special Hydraulic Oils (Consult Factory)
- Operator Tool Tray
- Accessory Packages
 - SkyPower® Package
 - SkyGlazier
 - SkyWelder® Package

Note: Some options may increase lead time, and some option combinations may not be available.

1. Includes Battery Blanket, Hydraulic Tank Heater, Block Heater.
2. Includes Arctic Hydraulic Hoses (Drive, Steer), Main Boom Cable, Extreme Cold Engine Oil, Fuel Conditioner, Engine Block Heater, Battery Blanket, Glow Plugs, Hydraulic Tank Heater, Oversized Footswitch And Arctic Hydraulic Oil.
3. Includes console cover, boom wipers and cylinder bellows.
4. Includes platform work lights, head and tail lights, amber beacon.

Additional accessories and options available via JLG Aftermarket.

400 HC3 SERIES

TELESCOPIC HI-CAPACITY BOOM LIFTS



Dimensions

All dimensions are approximate.

400S HC3

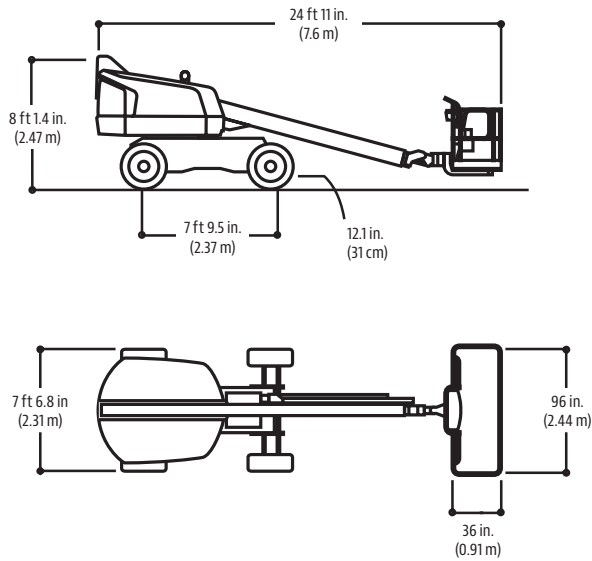

460SJ HC3

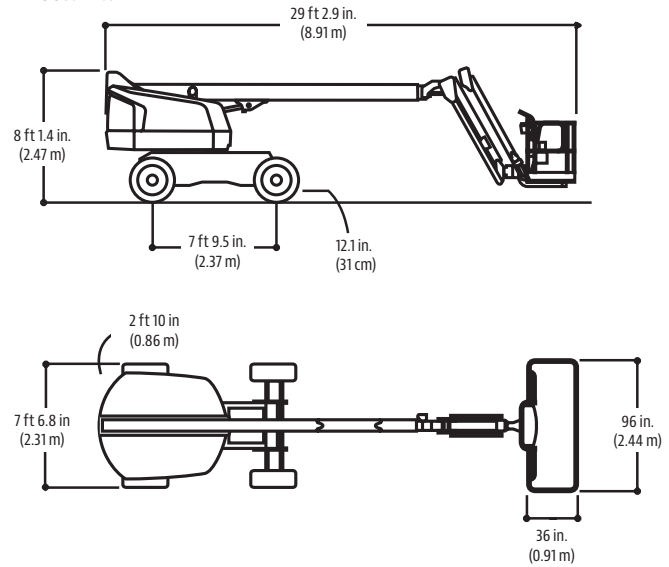

Reach Diagrams

400S HC3

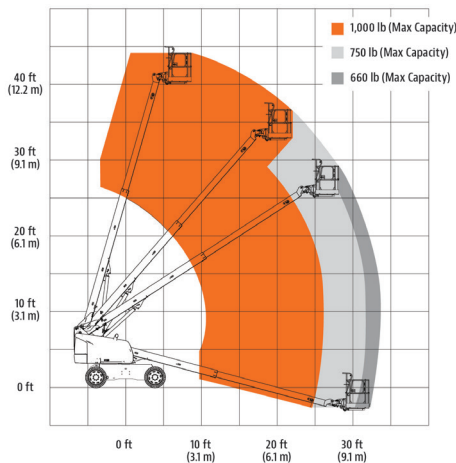

460SJ HC3

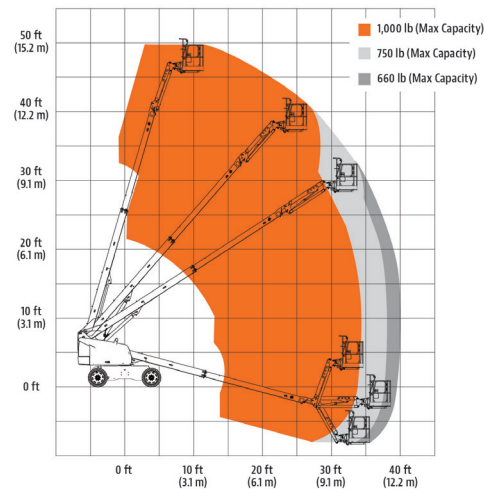

The JLG "1 & 5" Warranty

We provide coverage for one (1) full year, and cover all specified major structural components for five (5) years. Due to continuous product improvements, we reserve the right to make specification and/or equipment changes without prior notification. This machine meets or exceeds applicable ANSI and CSA requirements based on machine configuration as originally manufactured for intended applications. Please reference the serial number plate on the machine for additional information.

Part No.: 3131033
R012220
Printed in USA



JLG Industries, Inc.
1 JLG Drive
McConnellsburg, PA 17233-9533
Telephone 717-485-5161
Toll-free in US 877-JLG-LIFT
Fax 717-485-6417
www.jlg.com

An Oshkosh Corporation Company